

严酷环境HMI系列

极端条件下的首选!

- 实践验证的长期可靠性
- 智能显示器在大太阳下可读
- PCAP触摸屏
- 全金属外壳
- 涂层板保护
- 扩展的工作温度
- 模块设计插件用于现场总线和网络
- 可选CODESYS集成PLC
- DNV-GL, IECEX, ATEX
- cULus, cULus Haz. Loc.



概述

eTOP500 Glass具有同类HMI领先的性能等级，已成为极端条件的首选。

现在增加了功能强大的 eX700 Glass 系列的严酷环境版本，IIoT 的好处是能够应用于即使最恶劣或遥远的地方。

从2011年起，EXOR的严酷环境人机界面 (HMI) 已经用于我们客户的环境中，不只是设备的使用环境严酷，而且对于操作员而言它的可靠性工作也是至关重要的。

eTOP500 Glass已经能够面对这种挑战，利用它的同类领先的性能等级，它已经成为极端条件下的首选HMI。

现在增加了功能强大的 eX700 Glass 系列的严酷环境版本，IIoT 的好处是能够应用于即使最恶劣或遥远的地方。

该系列产品组合了坚固的设计和使用JMobile软件，其使HMI的操作非常容易：重点是在环境困难时。经由模块实现连接到各种的网络和协议，有助于在现有的架构中实施这些HMI。

eX707G - 技术数据



System Resources	
Display - Colors	7" TFT 16:9 LED - 16M
Resolution	800x480, WVGA
Brightness	600 Cd/m ² typ.
Dimming	to 0%
Touchscreen	True Glass Projected Capacitive, Multitouch
CPU	ARM Cortex-A9 dual core 800 MHz
Operating System	Linux RT
Flash	4 GB
RAM	1 GB
Real Time Clock, RTC Back-up, Buzzer	Yes
Interface	
Ethernet port	3 (port 0 - 10/100/1000, port 1 - 10/100, port 2 - 10/100)
USB port	2 (Host V2.0, max. 500 mA)
Serial port	1 (RS-232, RS-485, RS-422, software configurable) Max 3 serial ports using plug-in modules.
SD card	Yes
Expansion	2 slot for plug in modules
Ratings	
Power supply	24 Vdc (10 to 32 Vdc)
Current Consumption	0.7 A at 24 Vdc (max.)
Input Protection	Electronic
Battery	Rechargeable Lithium battery, not user-replaceable
Environment Conditions	
Operating Temp	-20° to +60 °C (vertical installation) Plug-in modules and USB devices may limit max temperature to +50 °C
Storage Temp	-20°C to +70°C
Operating / Storage Humidity	5-85% RH, non condensing
Protection Class	IP66 (front), IP20 (rear) Type: 12, 4X
Dimensions and Weights	
Faceplate LxH	187x147 mm (7.36x5.79")
Cutout AxB	176x136 mm (6.93x5.35")
Depth D+T	47+8 mm (1.85+0.31")
Weight	1.5 Kg
Approvals	
CE	Emission EN 61000-6-4, Immunity EN 61000-6-2 for installation in industrial environments, Emission EN 60945, Immunity EN 60945 for marine environments
UL	cULus: UL61010-1 / UL61010-2-201
UL	cULus: Class I Div. 2
IECEX	Zone 2/22: Ex nA IIC T5 Gc, Ex tc IIIC T95°C Dc
ATEX	Zone 2/22: II 3 G Ex nA IIC T5 Gc II 3 D Ex tc IIIC T95°C Dc
DNV-GL	Yes
EU RO MR	Yes
RCM	Yes

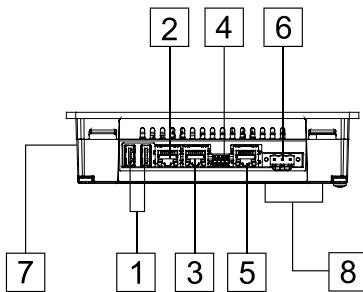

- 1 USB 端口 1 和 2
- 2 Ethernet 端口 2 (10/100 Mb)
- 3 Ethernet 端口 1 (10/100 Mb)
- 4 串口
- 5 Ethernet 端口 0 (10/100/1000 Mb)
- 6 供电
- 7 SD 卡插槽
- 8 2 扩展插槽用于插入式模块

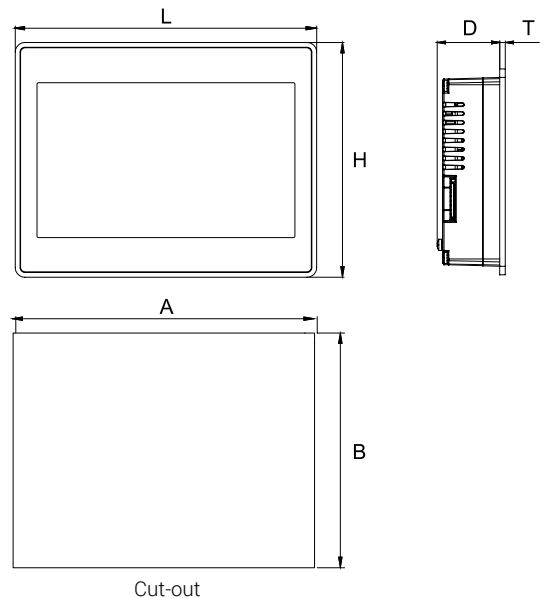

订货说明

型号	货号	说明
eX707G	+EX707GU5P1	7" widescreen TFT color with multitouch projected capacitive touchscreen. 3 Ethernet ports, 1 serial port, 2 USB ports. JMobile runtime.

eX710G - 技术数据



System Resources	
Display - Colors	10.1" TFT 16:9 LED - 16M
Resolution	1280x800, WXGA
Brightness	800 Cd/m ² typ.
Dimming	to 0%
Touchscreen	True Glass Projected Capacitive, Multitouch
CPU	ARM Cortex-A9 dual core 800 MHz
Operating System	Linux RT
Flash	4 GB
RAM	1 GB
Real Time Clock, RTC Back-up, Buzzer	Yes
Interface	
Ethernet port	3 (port 0 - 10/100/1000, port 1 - 10/100, port 2 - 10/100)
USB port	2 (Host V2.0, max. 500 mA)
Serial port	1 (RS-232, RS-485, RS-422, software configurable) Max 3 serial ports using plug-in modules.
SD card	Yes
Expansion	2 slot for plug in modules
Ratings	
Power supply	24 Vdc (10 to 32 Vdc)
Current Consumption	1.0 A at 24 Vdc (max.)
Input Protection	Electronic
Battery	Rechargeable Lithium battery, not user-replaceable
Environment Conditions	
Operating Temp	-20° to +60 °C (vertical installation) Plug-in modules and USB devices may limit max temperature to +50 °C
Storage Temp	-20°C to +70°C
Operating / Storage Humidity	5-85% RH, non condensing
Protection Class	IP66 (front), IP20 (rear) Type: 12, 4X
Dimensions and Weights	
Faceplate LxH	282x197 mm (11.10x7.80")
Cutout AxB	271x186 mm (10.67x7.32")
Depth D+T	56+8 mm (2.20+0.33")
Weight	2.5 Kg
Approvals	
CE	Emission EN 61000-6-4, Immunity EN 61000-6-2 for installation in industrial environments, Emission EN 60945, Immunity EN 60945 for marine environments
UL	cULus: UL61010-1 / UL61010-2-201
UL	cULus: Class I Div. 2
IECEX	Zone 2/22: Ex nA IIC T5 Gc, Ex tc IIIC T95°C Dc Zone 2/22: II 3 G Ex nA IIC T5 Gc
ATEX	II 3 D Ex tc IIIC T95°C Dc
DNV-GL	Yes
RCM	Yes

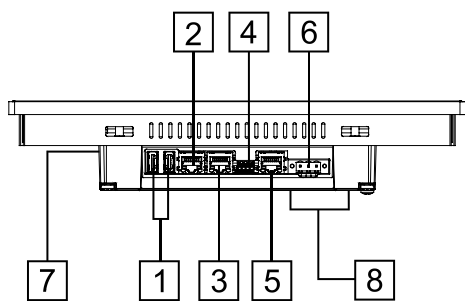

- 1 USB 端口 1 和 2
- 2 Ethernet 端口 2 (10/100 Mb)
- 3 Ethernet 端口 1 (10/100 Mb)
- 4 串口
- 5 Ethernet 端口 0 (10/100/1000 Mb)
- 6 供电
- 7 SD 卡插槽
- 8 2 扩展插槽用于插入式模块

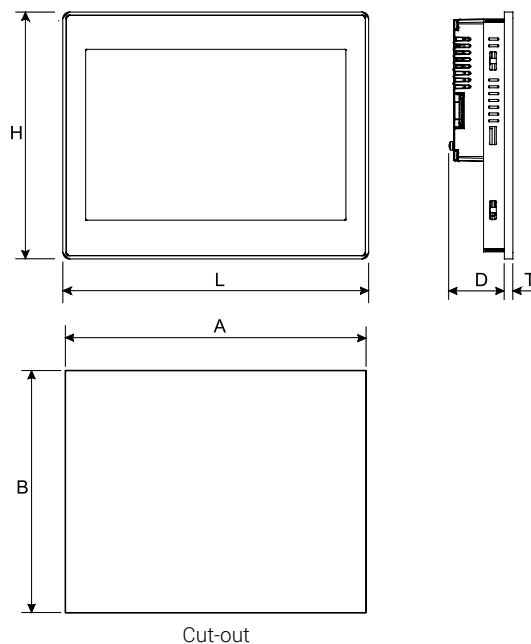

订货说明

型号	货号	说明
eX710G	+EX710GU5P1	10.1" widescreen TFT color with multitouch projected capacitive touchscreen. 3 Ethernet ports, 1 serial port, 2 USB ports. JMobile runtime.

eTOP507G - 技术数据



System Resources	
Display - Colors	7" TFT 16:9 LED - 64K
Resolution	800x480, WVGA
Brightness	400 Cd/m ² typ.
Dimming	to 0%
Touchscreen	True Glass Projected Capacitive
CPU	ARM Cortex-A8 - 600 MHz
Operating System	Microsoft Windows CE 6.0
Flash	128 MB
RAM	256 MB
Real Time Clock, RTC Back-up, Buzzer	Yes, Yes, Yes
Interface	
Ethernet port	2 (port 0 - 10/100, port 1 - 10/100) with integrated Switch
USB port	2 (port 1 - Host V2.0, port 2 - Host V2.0/1.1)
Serial port	1 (RS-232, RS-485, RS-422, software configurable) Max 3 serial ports using plug-in modules.
SD card	Yes
Expansion	2 slot for plug in modules
Ratings	
Power supply	24 Vdc (10 to 32 Vdc)
Current Consumption	0.8 A at 24 Vdc (max.)
Input Protection	Automatic
Battery	Rechargeable Lithium battery, not user-replaceable
Environment Conditions	
Operating Temp	-20 to +60 °C (vertical installation)
Storage Temp	-40 to +85 °C
Operating / Storage Humidity	5-85% RH, non condensing
Protection Class	IP69K (front), IP20 (rear) Type: 12, 4X
Dimensions and Weights	
Faceplate LxH	187x147 mm (7.36x5.79")
Cutout AxB	176x136 mm (6.93x5.35")
Depth D+T	47+8 mm (1.85+0.31")
Weight	Approx 1.0 Kg
Approvals	
CE	Emission EN 61000-6-4 Immunity EN 61000-6-2 for installation in industrial environments
UL	cULus: UL508
UL	cULus: Class I Div. 2
IECEX	Zone 2/22: Ex nA IIC T4 Gc -20<Tamb<+60°C, Ex tc IIIC T105°C Dc
ATEX	Zone 2/22: II 3G Ex nA IIC T4 Gc -20<Tamb<+60°C II 3D Ex tc IIIC T105°C Dc
DNV-GL	Yes
RCM	Yes

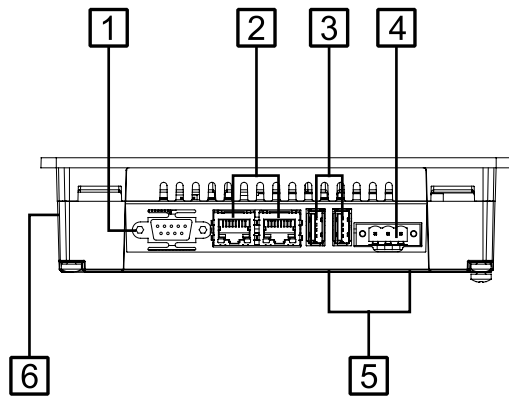

- 1 串口
- 2 2x Ethernet 端口
- 3 2xUSB 端口
- 4 供电
- 5 2x 扩展插槽用于插入式模块
- 6 SD 卡插槽

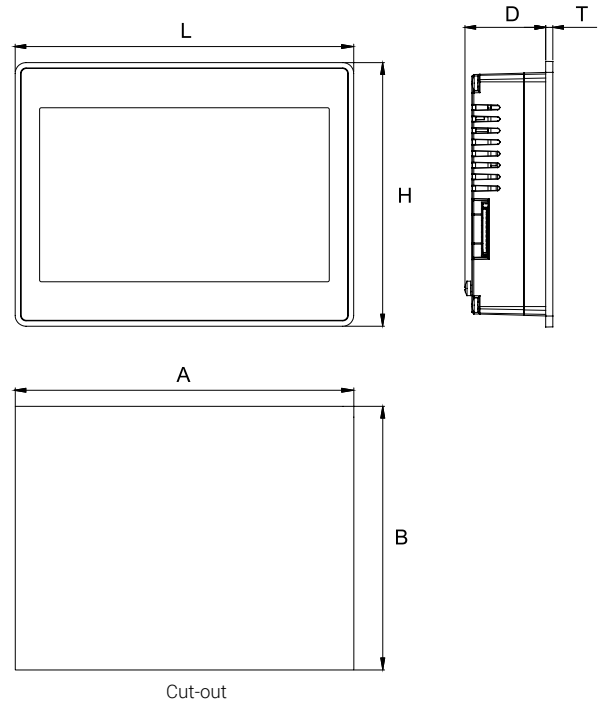

订货说明

型号	货号	说明
eTOP507G	+ETOP507U5P1	7" widescreen TFT color projected capacitive touchscreen with Ethernet and USB interfaces. JMobile runtime.

eTOP507MG - 技术数据



System Resources	
Display - Colors	7" TFT 16:9 LED - 64K
Resolution	800x480, WVGA
Brightness	400 Cd/m ² typ.
Dimming	to 0%
Touchscreen	True Glass Projected Capacitive
CPU	ARM Cortex-A8 - 1 GHz
Operating System	Microsoft Windows CE 6.0
Flash	256 MB
RAM	256 MB
Real Time Clock, RTC Back-up, Buzzer	Yes, Yes, Yes
Interface	
Ethernet port	2 (port 0 - 10/100, port 1 - 10/100) with integrated Switch
USB port	2 (port 1 - Host V2.0, port 2 - Host V2.0/1.1)
Serial port	1 (RS-232, RS-485, RS-422, software configurable) Max 3 serial ports using plug-in modules.
SD card	Yes
Expansion	2 slot for plug in modules
Ratings	
Power supply	24 Vdc (10 to 32 Vdc)
Current Consumption	0.9 A at 24 Vdc (max.)
Input Protection	Automatic
Battery	Rechargeable Lithium battery, not user-replaceable
Environment Conditions	
Operating Temp	-20 to +60 °C (vertical installation)
Storage Temp	-40 to +85 °C
Operating / Storage Humidity	5-85% RH, non condensing
Protection Class	IP69K (front), IP20 (rear) Type: 12, 4X
Dimensions and Weights	
Faceplate LxH	187x147 mm (7.36x5.79")
Cutout AxB	176x136 mm (6.93x5.35")
Depth D+T	47+8 mm (1.85+0.31")
Weight	Approx 1.0 Kg
Approvals	
CE	Emission EN 61000-6-4 Immunity EN 61000-6-2 for installation in industrial environments
UL	cULus: UL508
UL	cULus: Class I Div. 2
IECEX	Zone 2/22: Ex nA IIC T4 Gc -20<Tamb<+60°C, Ex to IIIC T105°C Dc
ATEX	Zone 2/22: II 3G Ex nA IIC T4 Gc -20<Tamb<+60°C II 3D Ex to IIIC T105°C Dc
DNV-GL	Yes
RCM	Yes

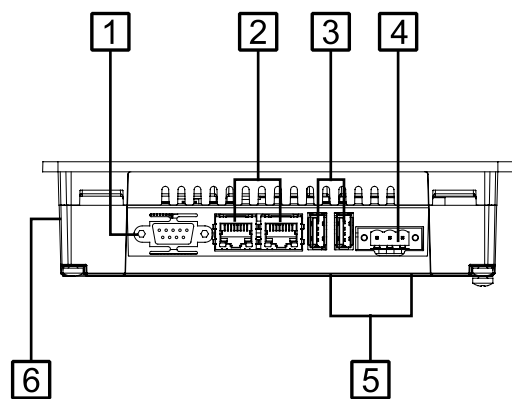

- 1 串口
- 2 2x Ethernet 端口
- 3 2x USB 端口
- 4 供电
- 5 2x 扩展插槽用于插入式模块
- 6 SD 卡插槽用于可拆卸卡

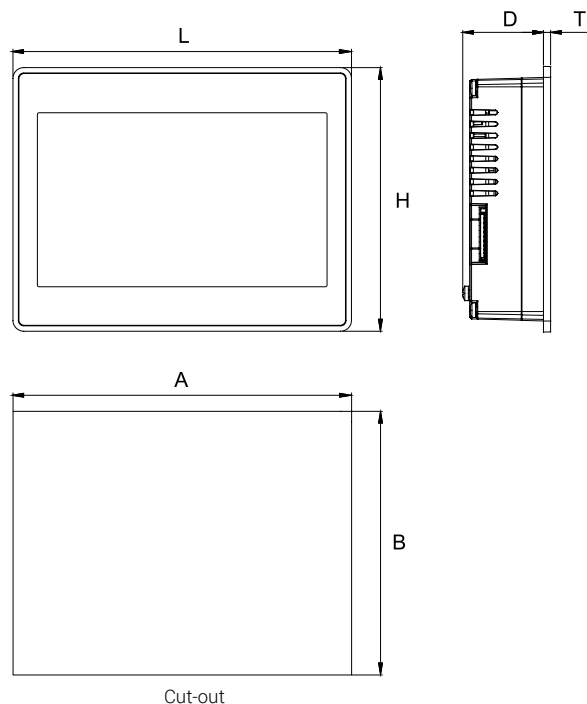

订货说明

型号	货号	说明
eTOP507MG	+ETOP507MU5P1	7" widescreen TFT color projected capacitive touchscreen with Ethernet and USB interfaces. JMobile runtime.

eTOP510G - 技术数据



System Resources	
Display - Colors	10.1" TFT 16:9 LED - 64K
Resolution	1280x800, WXGA
Brightness	600 Cd/m ² typ.
Dimming	to 0%
Touchscreen	True Glass Projected Capacitive
CPU	ARM Cortex-A8 - 1 GHz
Operating System	Microsoft Windows CE 6.0
Flash	256 MB
RAM	256 MB
Real Time Clock, RTC Back-up, Buzzer	Yes, Yes, Yes
Interface	
Ethernet port	2 (port 0 - 10/100, port 1 - 10/100) with integrated Switch
USB port	2 (port 1 - Host V2.0, port 2 - Host V2.0/1.1)
Serial port	1 (RS-232, RS-485, RS-422, software configurable) Max 3 serial ports using plug-in modules.
SD card	Yes
Expansion	2 slot for plug in modules
Ratings	
Power supply	24 Vdc (10 to 32 Vdc)
Current Consumption	1.0 A at 24 Vdc (max.)
Input Protection	Automatic
Battery	Rechargeable Lithium battery, not user-replaceable
Environment Conditions	
Operating Temp	-20 to +60 °C (vertical installation)
Storage Temp	-20 to +70 °C
Operating / Storage Humidity	5-85% RH, non condensing
Protection Class	IP69K (front), IP20 (rear) Type: 12, 4X
Dimensions and Weights	
Faceplate LxH	282x197 mm (11.10x7.80")
Cutout AxB	271x186 mm (10.67x7.32")
Depth D+T	52+8 mm (2.20+0.33")
Weight	Approx 2.7 Kg
Approvals	
CE	Emission EN 61000-6-4 Immunity EN 61000-6-2 for installation in industrial environments
UL	cULus: UL508
UL	cULus: Class I Div. 2
IECEX	Zone 2/22: Ex nA IIC T4 Gc -20<Tamb<+60°C, Ex tc IIIC T105°C Dc Zone 2/22: II 3G Ex nA IIC T4 Gc -20<Tamb<+60°C
ATEX	II 3D Ex tc IIIC T105°C Dc
DNV-GL	Yes
RCM	Yes

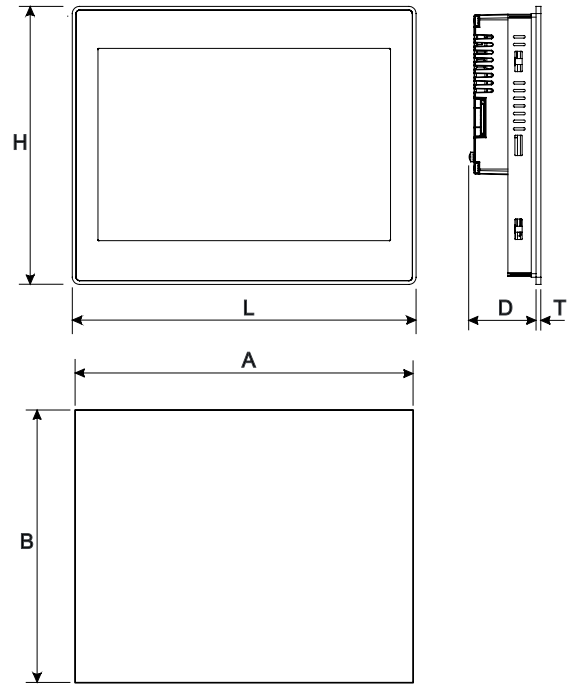
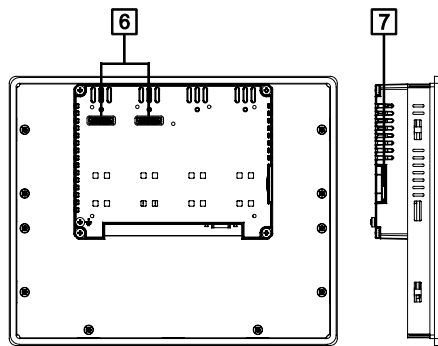
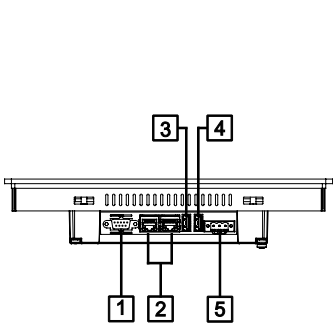

Cut-out

- 1 串口
- 2 2x Ethernet 端口
- 3 USB 端口 (版本 2.0 - 1.1)
- 4 USB 端口 (版本 2.0 仅高速)
- 5 供电
- 6 2x 扩展插槽用于插入式模块
- 7 SD 卡插槽

订货说明

型号	货号	说明
eTOP510G	+ETOP510U5P1	10.1" widescreen TFT color with projected capacitive touchscreen. Ethernet and USB interfaces. JMobile runtime.

eTOP515G - 技术数据



System Resources	
Display - Colors	15" TFT LED - 64K
Resolution	1024x768, XGA
Brightness	1500 Cd/m ² typ
Dimming	to 0%
Touchscreen	True Glass Projected Capacitive
CPU	ARM Cortex-A8 - 1 GHz
Operating System	Microsoft Windows CE 6.0
Flash	256 MB
RAM	256 MB
Real Time Clock, RTC Back-up, Buzzer	Yes, Yes, Yes
Interface	
Ethernet port	2 (port 0 - 10/100, port 1 - 10/100) with integrated Switch
USB port	2 (port 1 - Host V2.0, port 2 - Host V2.0/1.1)
Serial port	1 (RS-232, RS-485, RS-422, software configurable) Max 3 serial ports using plug-in modules.
SD card	Yes
Expansion	2 slot for plug in modules
Ratings	
Power supply	24 Vdc (10 to 32 Vdc)
Current Consumption	1.4 A at 24 Vdc (max.)
Input Protection	Automatic
Battery	Rechargeable Lithium battery, not user-replaceable
Environment Conditions	
Operating Temp	-20 to +60 °C (vertical installation)
Storage Temp	-40 to +85 °C
Operating / Storage Humidity	5-85% RH, non condensing
Protection Class	IP69K (front), IP20 (rear) Type: 12, 4X
Dimensions and Weights	
Faceplate LxH	392x307 mm (15.43x12.08")
Cutout AxB	381x296 mm (15x11.65")
Depth D+T	56+8.5 mm (2.20+0.33")
Weight	Approx 4.0 Kg
Approvals	
CE	Emission EN 61000-6-4 Immunity EN 61000-6-2 for installation in industrial environments
UL	cULus: UL508
UL	cULus: Class I Div. 2
IECEX	Zone 2/22: Ex nA IIC T4 Gc -20<Tamb<+60°C, Ex tc IIIC T105°C Dc
ATEX	Zone 2/22: II 3G Ex nA IIC T4 Gc -20<Tamb<+60°C II 3D Ex tc IIIC T105°C Dc
DNV-GL	Yes
RCM	Yes

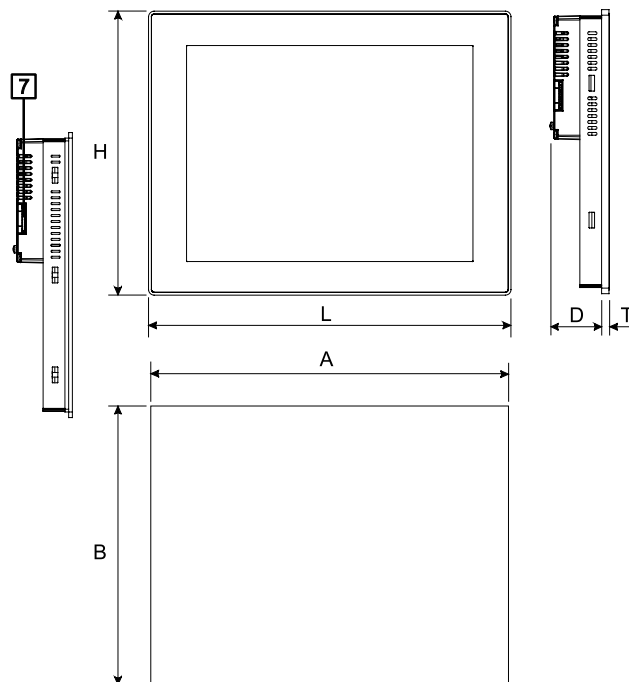
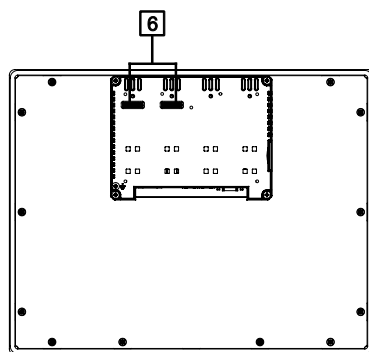
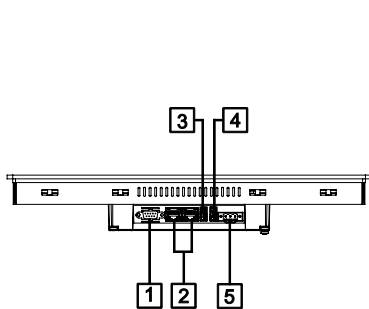

Cut-out

- 1 串口
- 2 2x Ethernet 端口
- 3 2x USB 端口
- 4 供电
- 5 2x 扩展插槽用于插入式模块
- 6 2x 插入式插槽
- 7 SD 卡插槽用于可拆卸卡

订货说明

型号	货号	说明
eTOP515G	+ETOP515U5P1	15" widescreen TFT color projected capacitive touchscreen with Ethernet and USB interfaces. JMobile runtime.

附件



型号	货号	说明
PLCM01 PLCM02 PLCM03 PLCM04 PLCM06 PLCM07	+PLCM01U0P1 +PLCM02U001 +PLCM03U0P1 +PLCM04U0P1 +PLCM06U0P1 +PLCM07U0P1	插入式模块 CAN 插入式模块 KNX/EIB (TP 接口) 插入式模块 RS-232 插入式模块 RS-422/485 带光隔离 插入式模块 Profibus DP slave 12 MB 插入式安全云连接器
CODESYS V3 SoftPLC PLCM01-CDS PLCM02-CDS PLCM05-CDS	+SWLC00R000000 +PLCM01U0P2 +PLCM02U002 +PLCM05U0P1	CODESYS V3 激活的许可证 插入式模块 CAN + CODESYS V2 插入式模块 KNX/EIB (TP 接口) + CODESYS V2 插入式模块 CODESYS V2
PLIO03 PLIO04 PLIO06 PLIO07	+PLIO03U0P1 +PLIO04U0P1 +PLIO06U0P1 +PLIO07U001	I/O 模块 with 20 DI 24 VDC, 12 DO 24 VDC 0,5 A, 8 AI (4 diff or 8 single or 4 PT100 or 4 TC), 4 AO, 1 PT100 冷接 I/O 模块 with 10 DI 24 VDC, 10 DO SSR 1.4 A, 4 可编程AI电压/PT100/TC, 4 AI 电压, 1 PT100 紧凑 I/O 模块. 8 DI, 6 DO, 1 继电器输出 紧凑 I/O 模块. 2 继电器输出