



快速测量 易于掌握 自动生成报告

STRAIN MEASUREMENT

应变测量系统 (TSK-8/32/64系列)



深圳市品控科技开发有限公司

TSK-8/32/64系列 应变测量系统



TSK系列功能优势 Product Features

- > 小型化低价格的精密测量仪器
- > 便携式，模块式扩展
- > 一键自动生成报表及报表合并功能
- > 构成简易，通过电脑来控制测量
- > 核心硬件美国进口，高精度，性能稳定

TSK系列型录 Series Catalogue

型号	最大输入通道CH	通道数	支持应变片阻值OHM
TSK-8-8C-12	8	8	120
TSK-32-8C-12	32	8	120
TSK-32-16C-12	32	16	120
TSK-32-24C-12	32	24	120
TSK-32-32C-12	32	32	120
TSK-64-40C-12	64	40	120
TSK-64-48C-12	64	48	120
TSK-64-56C-12	64	56	120
TSK-64-64C-12	64	64	120
TSK-8-8C-35	8	8	350
TSK-32-8C-35	32	8	350
TSK-32-16C-35	32	16	350
TSK-32-24C-35	32	24	350
TSK-32-32C-35	32	32	350
TSK-64-40C-35	64	40	350
TSK-64-48C-35	64	48	350
TSK-64-56C-35	64	56	350
TSK-64-64C-35	64	64	350

TSK系列技术规格 Technical Specifications

每个模块通道数	8通道应变信号输入
最多可容纳模块数	8个模块
采样频率	最高10KHz/通道
AD转换器分辨率	24位
滤波器	Delta-Sigma (带模拟预滤波)
输入连接器	D-Sub 25针或卡线端子
同步运行	最多可达8组, 64通道
采样模式	同步采集, 所有通道同步
惠斯通电桥类型	1/4桥 (两线式和三线式)
精度误差	0.3%
支持应变式传感器阻值	120欧姆或350欧姆
量程范围	±55500ue
非线性	±0.1%FS或以内
标度系数	3.5062nV/V/LSB
稳定性	增益漂移6ppm/°C
任意两端子间过压保护	±30V
机箱接口	USB2.0
供电电源	11-30VDC, 220VAC
工作环境	-40°C~70°C, 10%~90%RH, 无凝结
存储环境	-40°C~85°C, 5%~90%RH, 无凝结
防护等级	Ip40
重量	约2.5KG

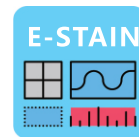

e-Strain
标配采集分析软件



TSK系列标准配件 Standard Accessories

- e-Strain采集分析软件
- USB电缆U20
- 专用包
- 电源适配器UIT318
- 连接电缆DB25-L1M
- 接线板C-12

TSK系列外形尺寸 Overall Dimensions

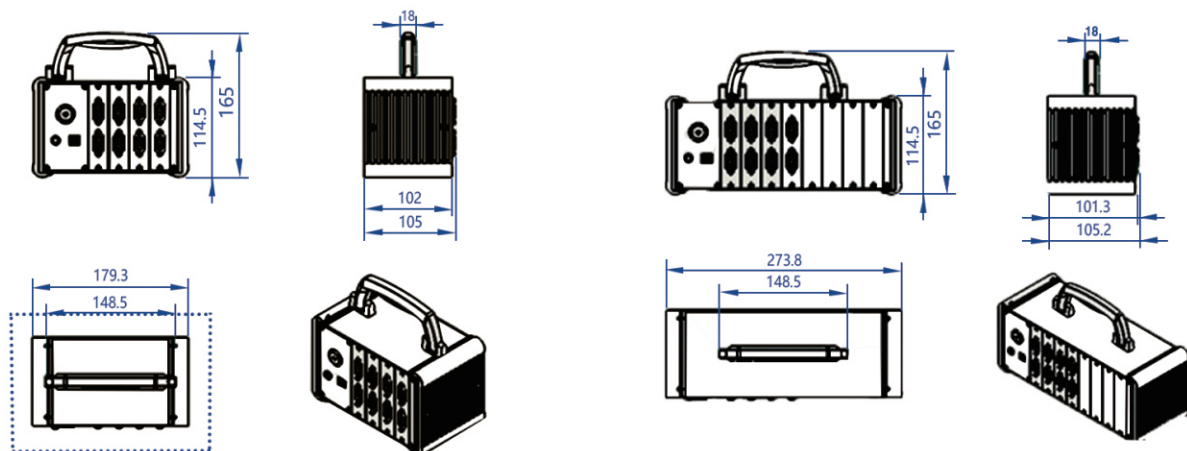

e-Strain标配采集分析软件

- 1 应变参数设置，各通道独立参数设置，包含阻值、应变花、灵敏系数等，并可保存参数模板，随时调用
- 2 配置多种方案，扫描条码，随时调用配置方案进行采集
- 3 AUTO自动识别功能，新手不需培训或简单培训便可以进行测量
- 4 多通道实时同步信号测量、显示与分析
- 5 可选.CSV格式和.AKD二进制格式，方便后期自己处理多样化报表格式

报表功能

Reporting features



原始波形记录及
回放数据库形式记录结果



测试结果导出为
PDF或 Excel格式



一键自动生成
专业PCB应变测试报表



依照 IPC-9704A
标准分析是否满足要求，
自动判定Pass or Fail



批量导入多份数据生成报表
(大幅提高了做报表的效率)

软件界面

Software Interface

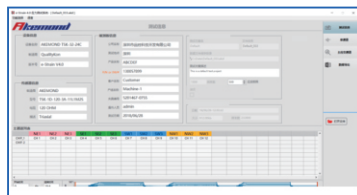
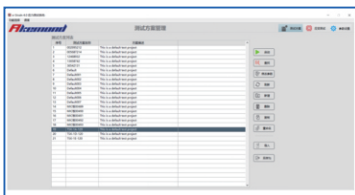

Default Unit						
Single Channel Value:						1000µat
Channel Name	Color	Max(Loc)	<<Time(s)	Min(Loc)	<<Time(s)	Result
Sensor_1	CH 1	588.7	5.43	-99.2	7.500	Fail
	CH 2	542.6	1.894	-28.9	1.00	Fail
	CH 3	23.8	1.204	-381.5	1.878	Pass
Sensor_2	CH 4	86.5	1.873	-38.2	17.348	Pass
	CH 5	280.2	8.029	-87.6	13.152	Pass
	CH 6	22.7	1.08	-188.6	1.891	Pass
Sensor_3	CH 7	468.4	1.873	-13.2	11.391	Pass
	CH 8	176.3	1.916	-371.6	1.279	Pass
	CH 9	86	5.503	-195.7	1.802	Pass
Sensor_4	CH 10	153.7	7.512	-38.3	11.378	Pass
	CH 11	183.7	17.187	-117.8	1.244	Pass
	CH 12	35.2	1.072	-145	13.488	Pass

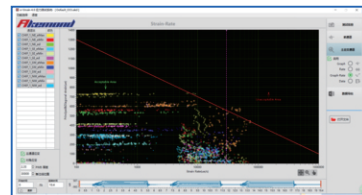
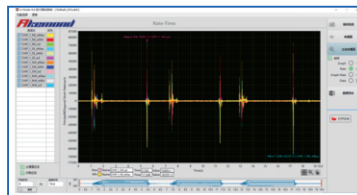
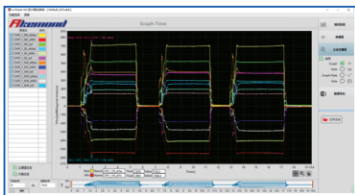

应用图例

Application Of Legend



PCBA行业

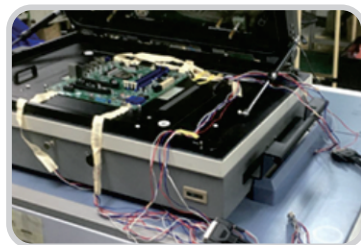
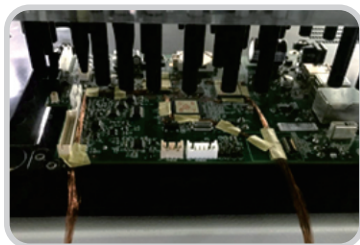
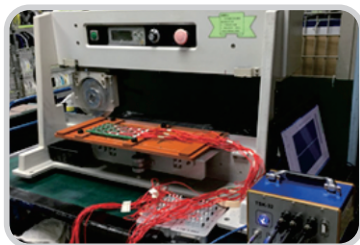
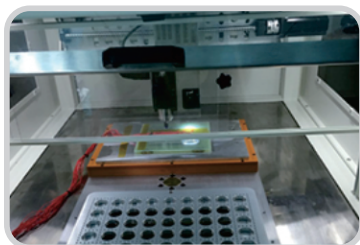

其他行业



挖掘机



桥梁

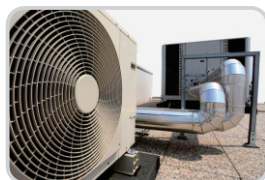

空调管道

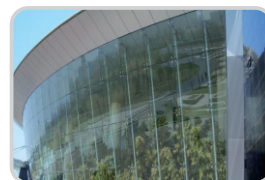

钢化玻璃

部分荣誉客户

Honor Customers



创机电业



厦门同致



仁宝



富士康



英伟达



TCL



京东方



三诺



比亚迪



东芝



丰达电机



东聚



英业达



格瑞普



海信



长虹



航盛



可立克



艾默生



长城开发



宏发股份



德赛西威



闻泰



珠海博杰



欧菲光



德昌电机



拓邦股份



得邦照明



扬子空调



三菱电机



志高空调

应变片选型 Strain Gages

产品形式	产品型号	阻值 (OHM)	敏感栅尺寸 (L*W)	基底尺寸 (L*W)	漆包线	PVC导线			
三轴Triaxial									
	TSK-1E-120-3A-11L30W05MS	120	1.1*1.0mm	4*4mm	30cm	50cm			
	TSK-1E-120-3A-11L50W05MS				50cm	50cm			
	TSK-1E-120-3A-11L50W3MS				50cm	300cm			
	TSK-1D-120-3A-11L50W05MS	120	1.1*1.0mm	2.5*2.7mm	50cm	50cm			
	TSK-1D-120-3A-11L1M2S				50cm	90cm			
	TSK-05R-120-3A-11L50W07MS				50cm	70cm			
	TSK-05R-120-3A-11L80W06MS				80cm	60cm			
	TSK-05R-120-3A-11L50W3MS				50cm	300cm			
	TSK-1A-120-3A-11L30W	120	1.1*1.0mm	φ5mm	30cm	30cm			
	TSK-1A-120-3A-11L30W07MS				30cm	70cm			
	TSK-1A-120-3A-11L30W3MS				30cm	300cm			
	TSK-1A-350-3A-11L30W	350	1.6*2.5mm	φ8mm	30cm	30cm			
	TSK-1A-350-3A-11L30W07MS				30cm	70cm			
双轴Biaxial									
	TSK-1A-120-2A-11L30W	120	1.1*1.0mm	φ5mm	30cm	30cm			
	TSK-1A-120-2A-11L30W07MS				30cm	70cm			
	TSK-1A-350-2A-11L30W	350	1.6*2.5mm	φ8mm	30cm	30cm			
	TSK-1A-350-2A-11L30W07MS				30cm	70cm			
单轴Uniaxial									
	TSK-1B-120-1A-11L1M2S	120	1.1*1.0mm	4*2mm	2cm	100cm			
	TSK-1B-120-1A-11L2M2S				2cm	200cm			
	TSK-1R-120-1A-11L1M2S				2cm	100cm			
	TSK-1R-120-1A-11L2M2S				2cm	200cm			
	TSK-05R-120-1A-11L1M2S	120	0.5*0.5mm	1.3*1.5mm	2cm	100cm			
	TSK-05R-120-1A-11L2M2S				2cm	200cm			
	TSK-1B-350-1A-11L1M2S				350	0.5*0.5mm	5*3.5mm	2cm	100cm
	TSK-1B-350-1A-11L2M2S							2cm	200cm

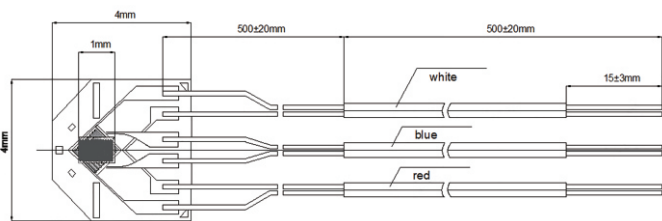

*** 以上应变片操作温度均在-30℃~80℃，如有特殊温度需求请电话联系。**

联系方式 Contact

深圳市品控科技开发有限公司(深圳总部)

电话：0755-81464182 传真：0755-89370613

邮箱：salyerll@qualitykon.com.cn

网址：www.qualitykon.com.cn

地址：深圳市宝安区福永街道福宁高新产业园26栋403

深圳市品控科技开发有限公司(苏州办事处)

孙先生13812715915 QQ:3003962039